



The sound absorber



DIVI put.on®

Modular soundproofing & privacy screen

$\alpha_w = 1,00$





The sound absorber



zz
zzz...



Divi put.on® – modular soundproofing & privacy screen $\alpha_w=1,00$

The lower the noise level, the greater the wellbeing and ability to concentrate

The cubes are made from a 94 mm thick, 100 % polyester acoustic fleece and a 2 mm thick, 100 % wool felt cover, resulting in a rated sound absorption coefficient of $\alpha_w=1,00$.





The sound absorber

Test results

Standing upright in the echo chamber – used as a partition

An upright partition was assembled on the floor of the echo chamber from 15 individual panels in four vertical rows (total height = 160 cm) and the system's usual ROPIMEX metal bases. The partition was tested at three irregularly distributed positions within the echo chamber.

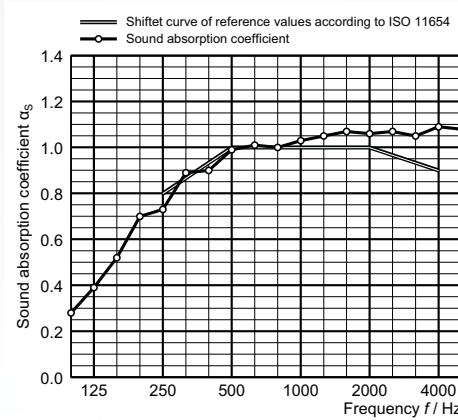

Frequency [Hz]	α_s 1/3 octave	α_p octave
100	0.28	0.40
125	0.39	
160	0.52	
200	0.70	0.75
250	0.73	
315	0.89	
400	0.90	
500	0.99	0.95
630	1.01	
800	1.00	
1000	1.03	1.00
1250	1.05	
1600	1.07	
2000	1.06	1.00
2500	1.07	
3150	1.05	
4000	1.09	1.00
5000	1.08	

Evaluation as per

- ISO 11654: evaluated sound absorption coefficient $\alpha_w = 1.00$; sound absorber class A
- ASTM C423: noise reduction coefficient NRC = 0.95; sound absorption average SAA = 0.96

Directly on the floor of the echo chamber – used as wall panel

The tested screen was placed directly on the floor of the echo chamber and surrounded with a circumferential frame on all sides. This frame consisted of 19 mm thick, coated MDF panels. The joints between the test specimen and surrounding frame and between the frame and the floor of the echo chamber were sealed with adhesive tape. The tested surface measured 4000 mm x 2800 mm length by width (excluding the frame) and was assembled from 38 individual panels.

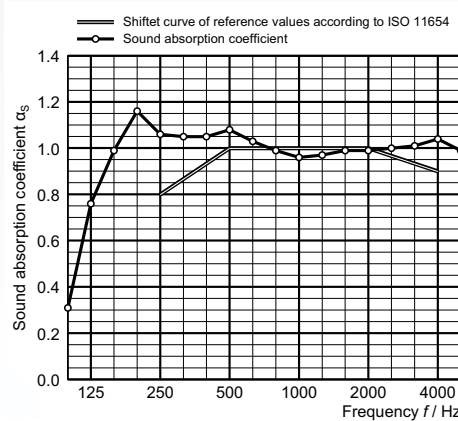

Frequency [Hz]	α_s 1/3 octave	α_p octave
100	0.31	0.70
125	0.76	
160	0.99	
200	1.16	1.00
250	1.06	
315	1.05	
400	1.05	1.00
500	1.08	
630	1.03	
800	0.99	0.95
1000	0.96	
1250	0.97	
1600	0.99	1.00
2000	0.99	
2500	1.00	
3150	1.01	
4000	1.04	1.00
5000	0.99	

Evaluation as per

- ISO 11654: evaluated sound absorption coefficient $\alpha_w = 1.00$; sound absorber class A
- ASTM C423: noise reduction coefficient NRC = 1.00; sound absorption average SAA = 1.03





Divi put.on®: Light-weight in 2 formats – with a great range of options

Multifunctional – easily assembled, dismantled and converted

Divi put.on® the light-weight amongst noise barriers, manages to be highly multifunctional with only 2 formats. As a room divider in an open space. As a VIP lounge for special occasions. As a beautifully designed eye-catcher at tradeshow and conferences. Or whatever Divi put.on® inspires you to at the moment.

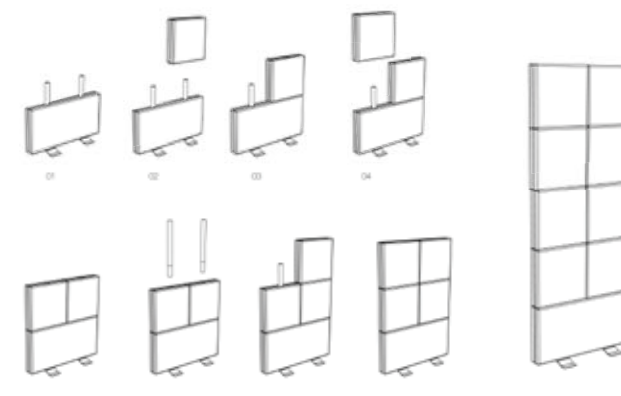



DIVI put.on® – PHILOSOPHY

An exciting interplay of colour, form and function

The new noise barrier should be sound-absorbing. Just as important: a light-weight that can be used by a single person without effort. In an eye-catching colour scheme. And so well-designed that it suits any modern office, apart from being made of the best materials, naturally. This was the work brief for our developers.

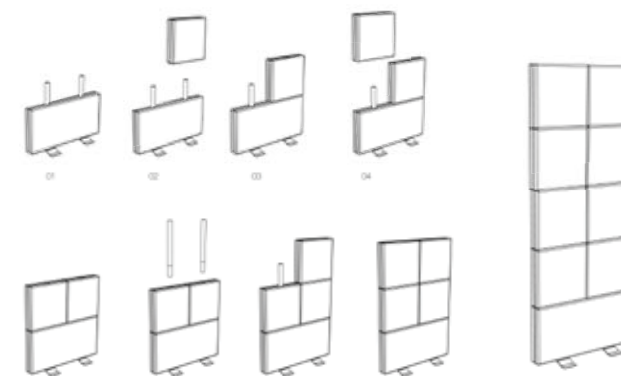

Cubes also available as transparent windows



DIVI put.on® – the easy way to a customized design

Soundproofing based on a modular principle

You don't need much for DIVI put.on®. Cubes in two selectable sizes. Plus base units, connectors and aluminium cover caps. Blindingly easy assembled to form a stable whole.

The freely configurable cubes can be arranged vertically, horizontally or at an offset. In a straight line, a curve or at right angles. Free-standing in an open space or leaning against walls. They will always fulfil their mission: to minimize the noise and maximize the well-being in the room.

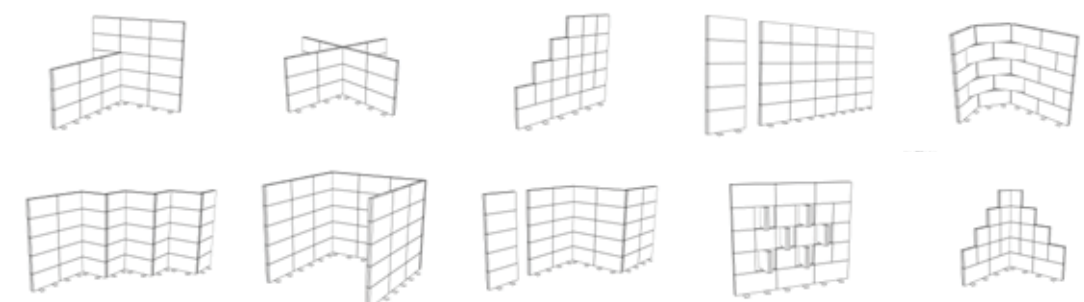



Divi put.on® – Configurations

One way today, another tomorrow

Divi put.on® is as easily and quickly reconfigured as it is to dismantle and reassemble the system. Every configuration brings out different aspects and helps to put the existing space to an optimal use. Just what is needed for the changing day-to-day requirements in a modern office.



Cubes in two formats

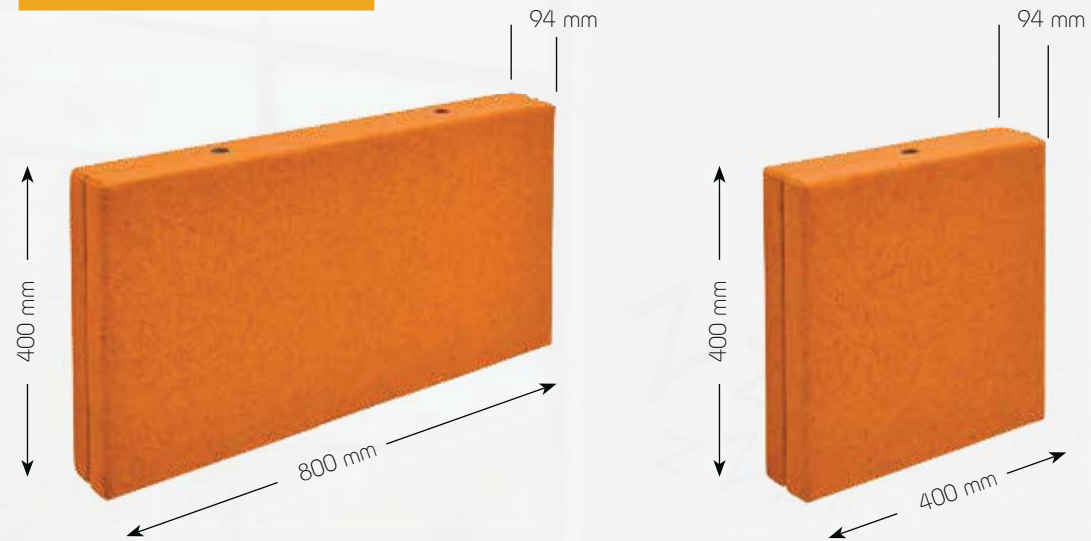

Also available as transparent PMMA windows in both formats.



Base unit

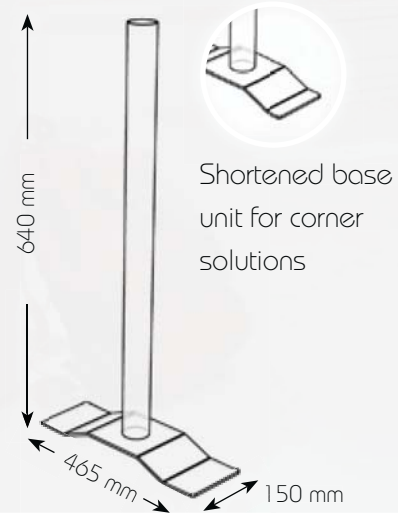

Connector



Cover cap



Corner connector for stabilization

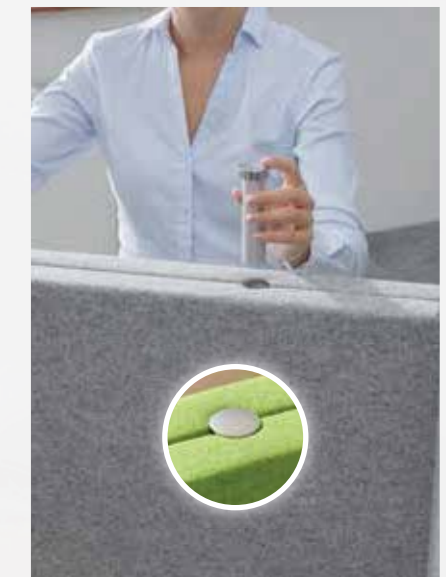
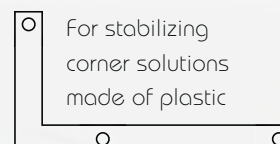

Materials and dimensions:

The cube is made from 100 % polyester acoustic fløecé and a 2 mm thick, 100% wool felt.



Base unit made from aluminium (B x H x T):

150 mm x 640 mm x 465 mm (640 mm ground clearance); Ø outside 30 mm, inside 25 mm; weight 1,05 kg

Connectors Grooved, round aluminium tubes :

Length 550 mm, offset 450 mm, 100 mm fit into the next tube, ensuring the greatest possible stability; Ø outside 30 mm, inside 25 mm; weight 0.45 kg

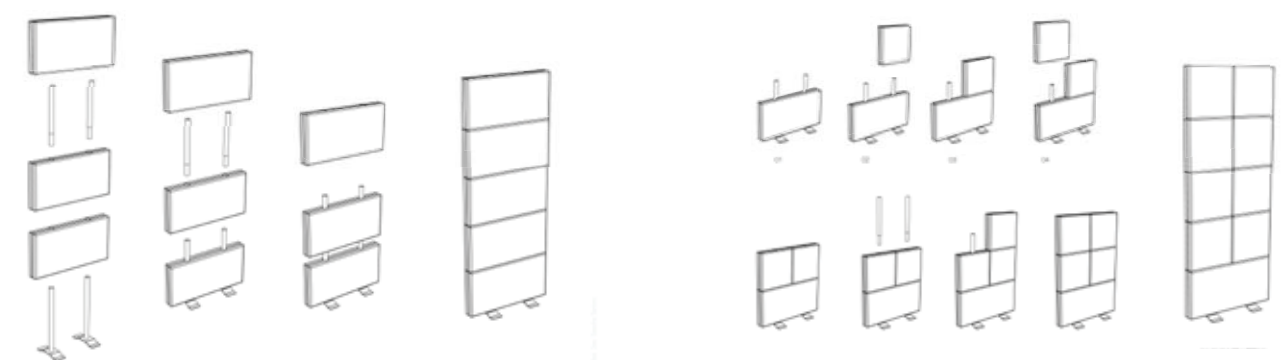



light grey (HG)



anthracite (AN)



light blue (HB)



yellow (GE)

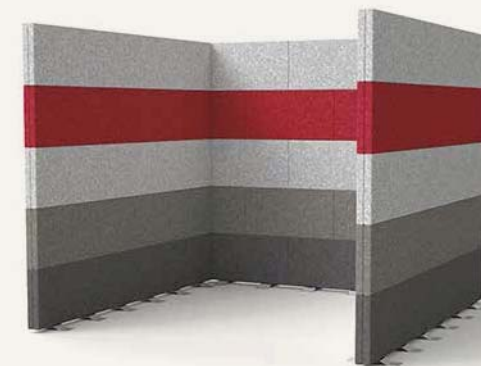

beige (B)



petrol (PE)



brown (BR)



green (GR)



red (RO)



orange (OR)



mocha (MO)

Simply configure your
DIVI put.on® online:

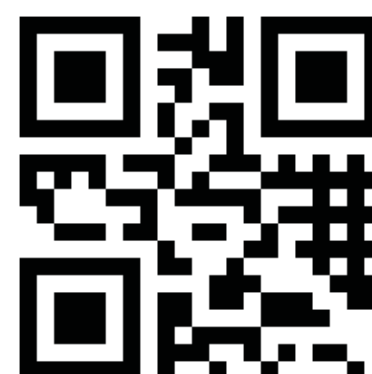

DIVI put.on® – Colour range

Colours at play – a pure delight

The colour choice says a lot. About the space and its function. About the people who are meant to meet and feel well there. About the impact one is aiming for, deliberately or not. DIVI put.on® comes in a balanced range of monochromes already. You are the designer: tone on tone or full of contrast. Reserved shades or a splash of colour. Playing with the colours in this manner becomes a sheer pleasure, and the room divider an eye-catcher.





Give your creativity free reign

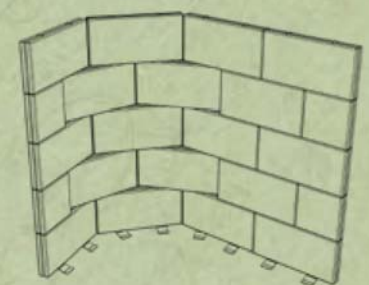
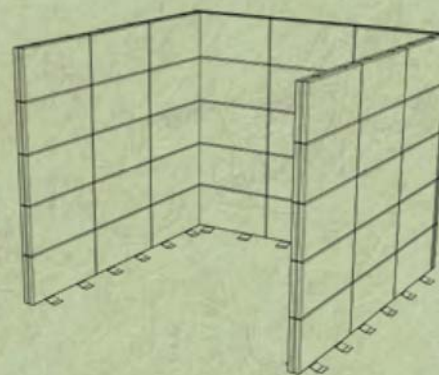
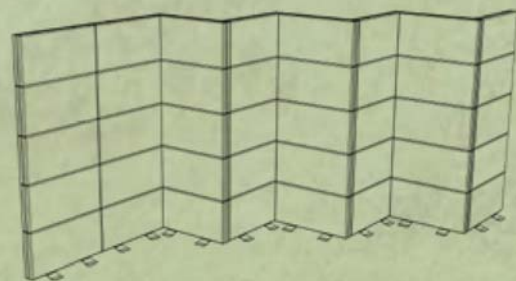
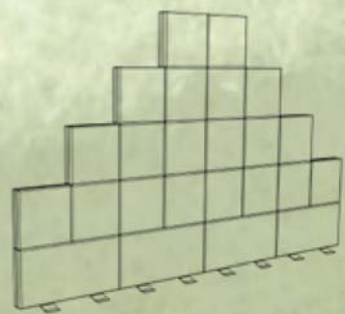
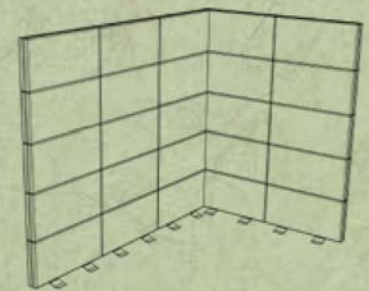
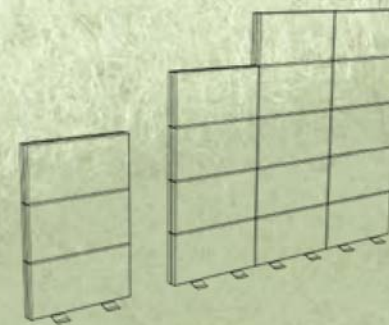
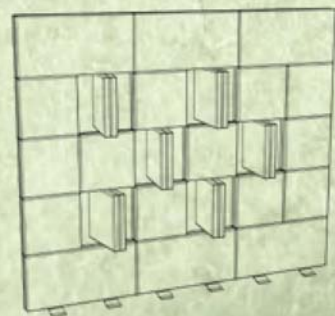
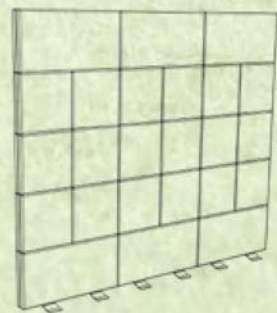
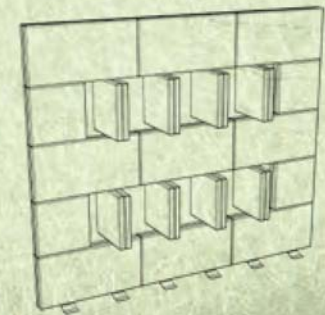
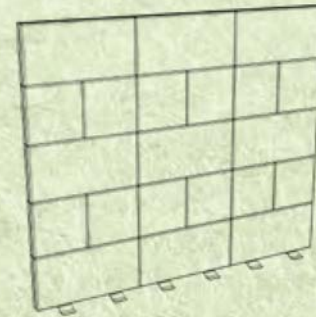
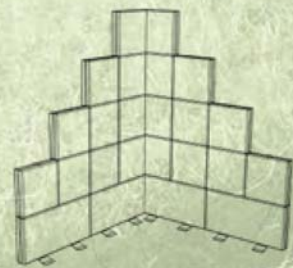
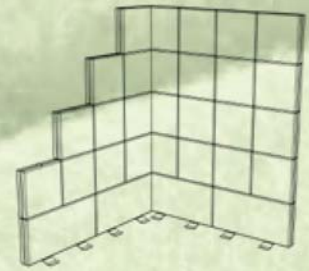
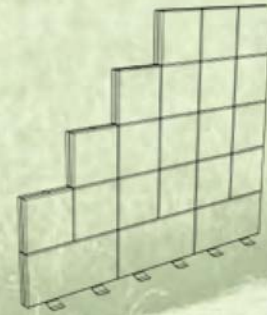
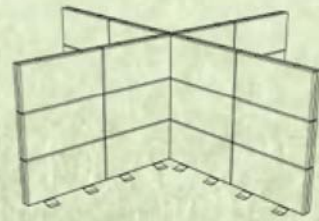
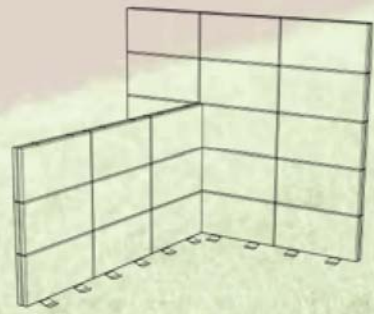



 Made in Germany



For further information and
configurator, visit :
www.diviline.de



Witteveen Projectinrichting
Ouderkerk a/d Amstel
Tel: 020 - 496 5030
info@witteveen.nl
www.project-inrichting.nl
www.scheidingswand.net

ROPIMEX R. OPEL GmbH · Geschäftsbereich Sichtschutz-Systeme OFFICE
Bildstocker Str. 12-14 · D-66538 Neunkirchen · Tel. +49 6821 9 12 77-0
Fax +49 6821 9 12 77-99 · info@diviline.de · www.diviline.de



ropimex[®]