



GLIMAKRA
OF SWEDEN

N E W S 2 0 1 9



THE HOME OF ACOUSTIC DESIGN

THE HOME OF ACOUSTIC DESIGN

Surrounded by glittering lakes and lush fields and forests, Glimåkra village is the heart of our design and production, and it has been so for 70 years. To ensure aesthetic and technical quality with high sound absorption, our designers and cabinet-makers work closely together, under the same roof.

We aspire for our business to have as little environmental impact as possible. Our products are timeless and of superior quality with a long lifecycle. We use pure and unmixed materials, as far as possible, which makes product recycling easier. To further shield the environment, we choose suppliers in the immediate area and thereby reducing transportation distances. Glimakra of Sweden is environmental and quality certified according to ISO 14001 and ISO 9001.

From the German Design Award we received the awards GOLD for Wakufuru and WINNER for LimbusFloor Subtle.

Limbus by Glimakra is a range of products focusing on acoustics and design. With Limbus and associated piping we have added a character that breathes design, quality and flexibility to many projects and at the same time resolved the acoustic conditions found in modern offices.

The increasingly popular activity based office requires new solutions to how furniture can help to create inspiring work environments for various kinds of work. We can offer a complete concept, designed within the range from acoustic reception to the modern workplace.

Discover products that are just as easy on the eye as on the ear.

“Wintery silent landscapes inspired Glimakra of Sweden and Johan Kauppi in their latest collaboration. A collection of furniture for well-balanced acoustic work environment – still keeping the office landscape open. It is all about horizontality, repetition and transparency.”

A common element in the northern sceneries is the airy way they built hey barn, often located in the middle of a field. When snow falls and covers the landscape - all sharp corners disappear, giving everything manmade an upholstered look. Just like the corners gets softened, all sharp sounds are muted. Silent open-air elements with soft lines, partitions and patterns – who wouldn't want to achieve the same characteristics in an open office?

Limbus Barn 270 works as silent, yet see through, pavilion that can be used for meetings and for workplaces. Placement angles and the number of combined pavilions will allow LimbusBarn 270 to resemble a cluster of sheds, intended to host creative meetings.

The entire furniture family is based on the same type of acoustic fabric covered baffles that has become one of Glimakra of Sweden's hallmarks.



LimbusBarn 270 has a white metal frame in 40 mm square tubes which stands on a frame in flat iron. The parts are coupled with hidden connection angles. 28 panels that form walls and roof are hooked onto the frame. Panels: 19 mm Lightweight MDF with 6 mm polyether and fabric. Matching colours in fabric piping. Metal frame: Powder coated NCS S 0500-N White. 100% recyclable material.

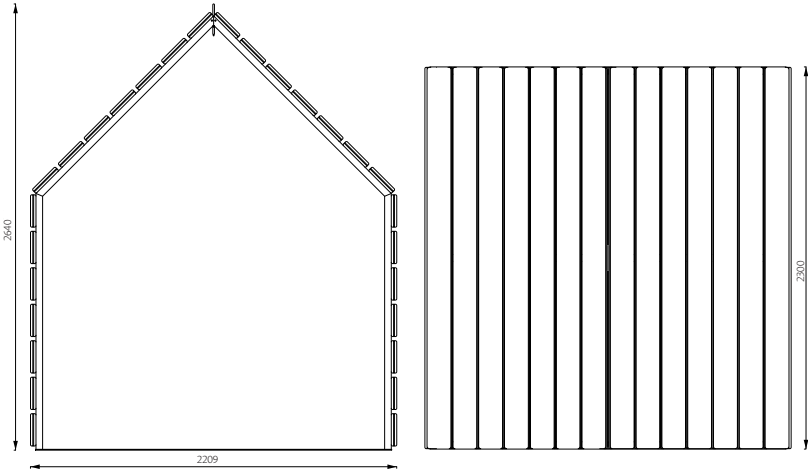



"These very changing scales emote a sense of nature, like a series of trees in which one is certainly not exactly like the next."

The soft form, a hybrid of both an organic and geometric nature, is intended as a relaxing form, absent of harsh edges, but not too abstract to cause visual distraction. It is simple and soothing in its shape. The variety of scales from one unit to the next allows for a playful or conservative arrangement based on the desires of those using the space.

These very changing scales emote a sense of nature, like a series of trees in which one is certainly not exactly like the next. The greater the combination of different scaled units, the less one feels like he or she is in an office, but rather in the open, in nature. The ability to arrange the multi-scaled units together lends to a beautiful and less predictable negative/positive space dichotomy that allows the units to work together nicely. They become sculptural in their assemblies.

Offers additional benefit of magnetic glass writing surface for independent and small group brainstorm and presentation activities. This promotes healthy collaboration amongst employees, while encouraging the sharing of ideas and information within a group.

With its wheels built into the base, Contour is easily moveable, harnessing the idea that the office is a living space that changes based on the needs of employees at any given moment.



This sound absorbing floor screen has optional write board. Frame: 6 mm sound absorbing polyether (Oeko-Tex) glued on both sides of a 19 mm sound reducing lightweight MDF. Writing board: 4 mm writing board in white glass with magnetic back. Pen strip: Solid ash with integrated eraser and magnets. Upholstery: Furniture nailed with fabric on both sides. The nail is hidden by a decorative piping. Wheel stand in ash natural or stain.

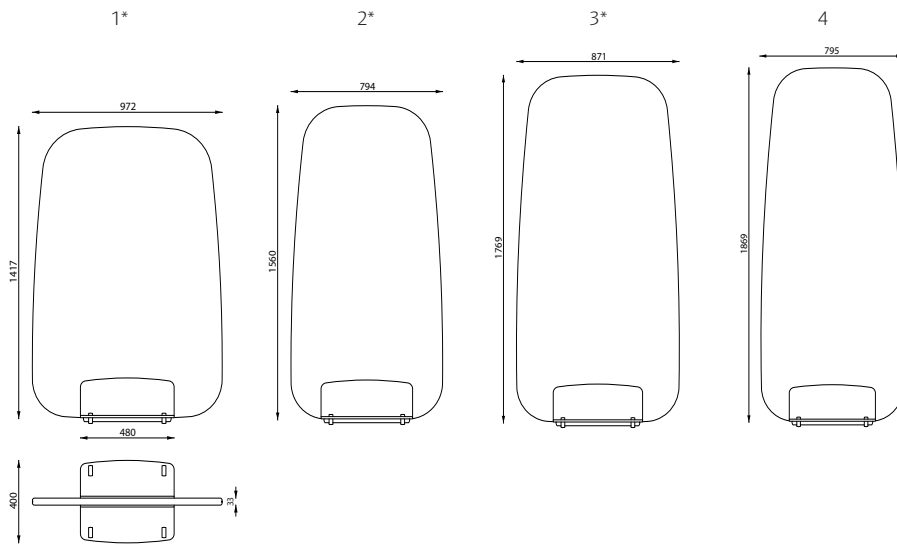

*Optional with writing board ContourFloor Glass



"Artificial nature that silences and allows recovery"

Several research reports, including Exeter University in Great Britain, show that nature is the best place for recovery. We need to see nature, and preferably stay in it, to feel good. Nature also provides the best acoustic environment. However, the interesting thing is that the brain records artificial nature in the same way and provides the same calming effect.

Despite all the information about the importance of nature in the workplace, plants are often not prioritized in the projects. Care and advanced technology for larger plant walls feels complicated and costly. From all this, the idea of JungleWall was awakened.

JungleWall is a series of sound absorbent leafs in different patterns. The material is made of felt and the leafs can be mounted in a way that creates a distance to the wall.

"It was important to experience a natural feeling in JungleWall, hence the distance between leaf and wall that provides a interesting movement in the leafs," says Niklas Madsen at Superlab.

In addition, the material in JungleWall, along with the distance to the wall, creates a good condition for sound absorption. JungleWall is advantageously used in large quantities in a workplace / public environment like a background wall.



JungleWall is a series of sound absorbent leaves in different patterns. The material is made of felt and the leaves can be mounted in a way that creates a distance to the wall. The material in JungleWall, along with the distance to the wall, creates a good condition for sound absorption. Leaf: 5 mm polyester felt , hook: solid ash. 100% recyclable material.

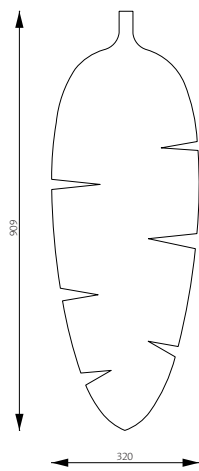

Banana Leaf

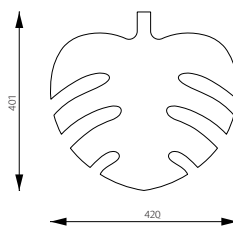

Monstera

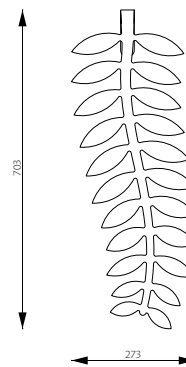

Royal Fern



"A wall-mounted, magnetic writing board in glass"

The activity-based office sets entirely different requirements from the traditional one. There is a need for workgroups to be able to have spontaneous meetings that encourage creativity.

Taking the step from sound absorbers to writing boards is not that far, on the contrary, they complement each other. The focus has therefore been on producing writing boards that match the sound absorbers, and to start with the Global series. It felt like a natural development of the product family.

The material on Global is a frame in MDF lacquer, in the same shade as the glass, which gives a monochrome look and fits perfectly with the fabric covered sound absorbent Global. The dimensions of the writing boards cover most needs, from small "remember" notes to big writing boards for conference rooms and other larger premises.

GlobalGlass can be used in a combination of sound absorbers and writing boards in a workplace or other creative environment.



The dimensions of the writing boards cover most needs, from small "remember" notes to big writing boards for conference rooms and other larger premises. Frame: MDF. Writing board: 4 mm i white painted glass with magnetic back side. Mounting: with aluminum rails screwed to the wall.

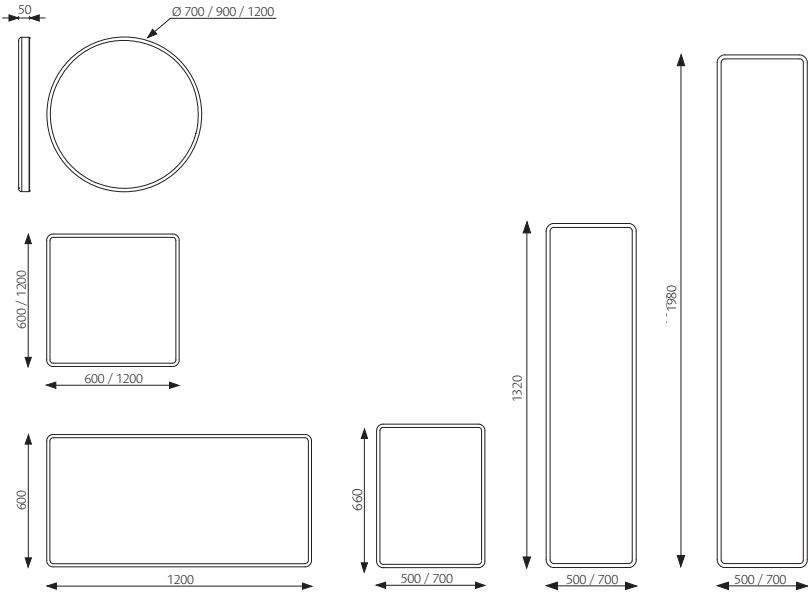



"A stylish modern accessory rail for desktop screens"

Most rails today work well but have an industrial appearance. The ambition was to develop an accessory rail that was flexible, stable and beautiful.

The rail should show as little metal as possible, this is achieved with a decor strip that you can also get in several materials, eg. cloth-covered, veneer or laminate.

Visually, the rail is perceived as two thin parallel lines that are linked to the rounded ends. As an alternative, it also comes with traditional straight finishes. The rail is either in white powder coating or natural anodised aluminum.

Accessories to the rail are available in various types of shelves in clear acrylic.

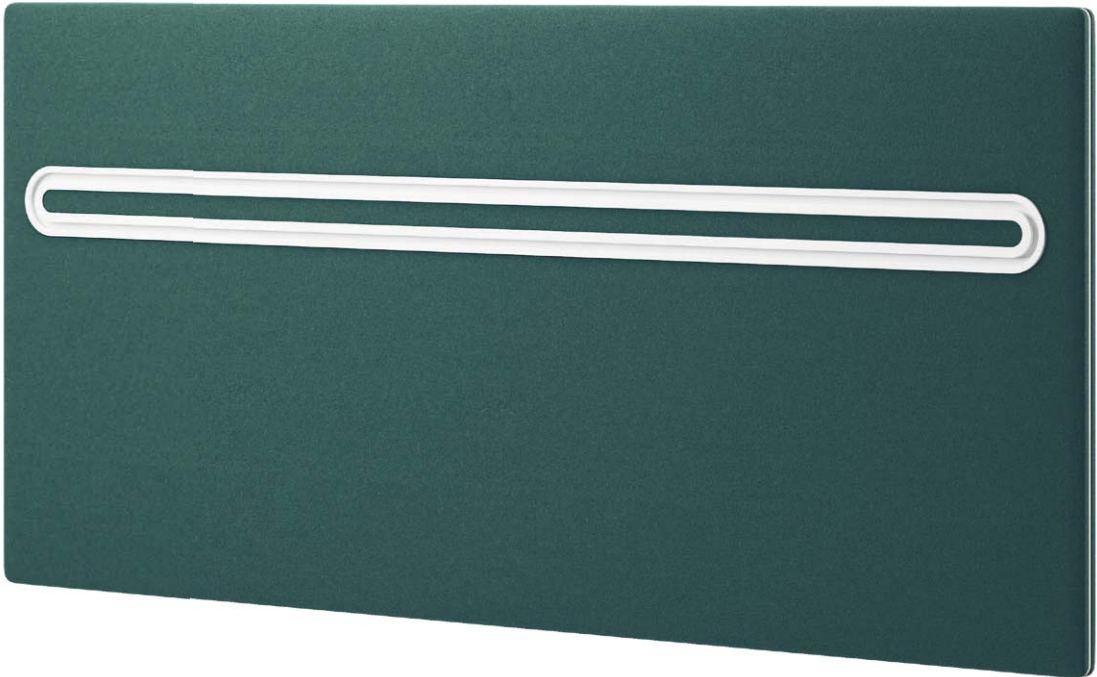

Glimma is a flexible, stable and beautiful accessory rail. Material: aluminium nature (anodised), double tracks 8 mm, c/c 54 mm. Most accessories on the market fit in the rail. However, external accessories should be tested / approved before ordering.

Glimma rail will be available as Recessed "round corner", Surface "Round corner" and Surface straight".

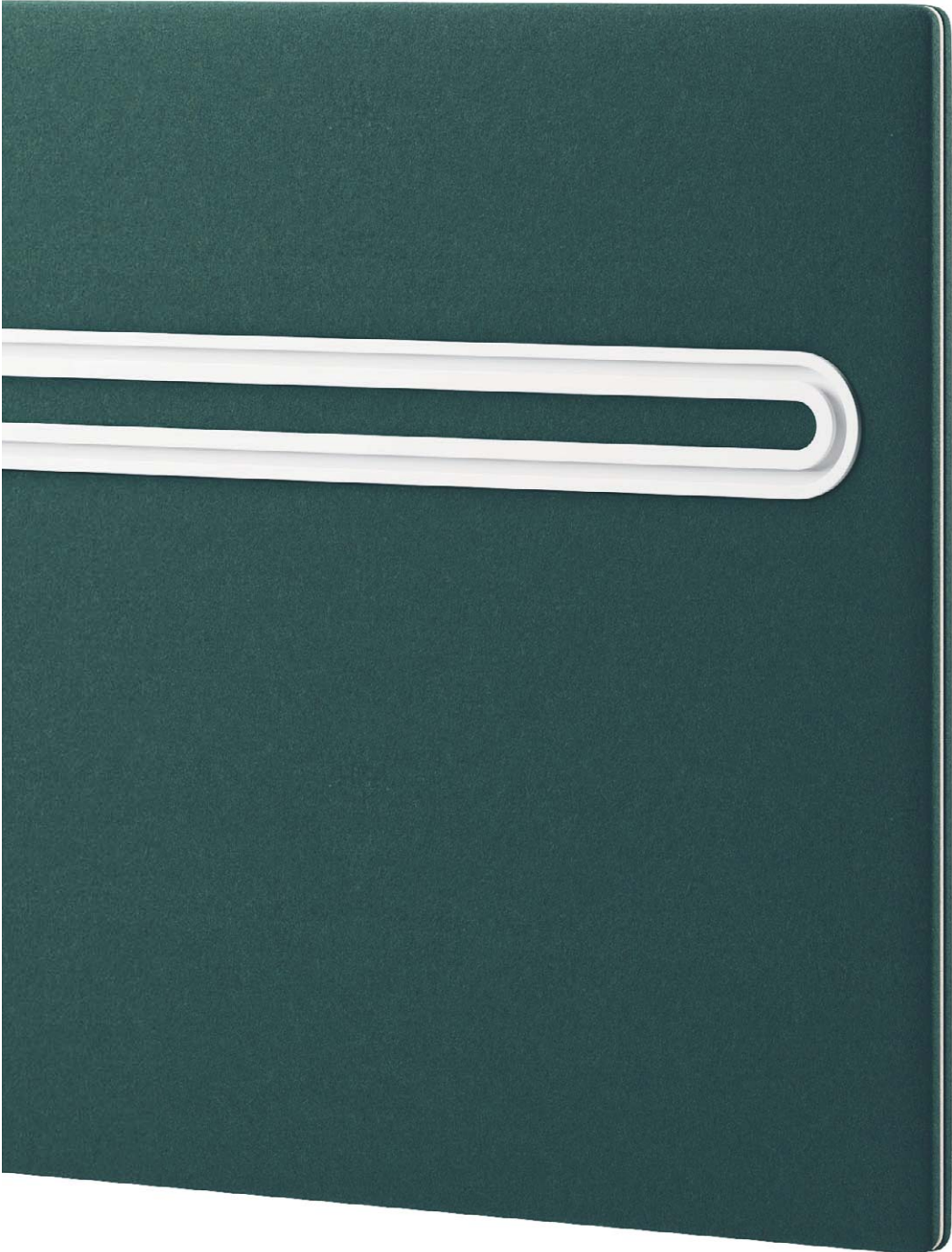



GLIMAKRA
OF SWEDEN

Glimakra of Sweden AB
Box 125, SE-289 04 Glimakra, Sweden
Försäljning 044-454 10 | Sales +46 44 454 20

info@glimakra.com | www.glimakra.com



Witteveen Projectinrichting
Ouderkerk a/d Amstel
Tel: 020 - 496 5030
info@witteveen.nl
www.scheidingswand.net
www.project-inrichting.nl